

The Advance Xitanium range of linear LED drivers is designed to provide OEMs with ultimate flexibility. These models are compatible with standard 0-10V dimming systems to deliver reliably smooth dimming performance down to a minimum of 1%. Enabled with SimpleSet technology, these drivers offer the needed flexibility and performance for the application with precise tuning of drive currents, selectable dimming curves and adjustable minimum dimming levels. With wide operating windows, slim profile and simple current adjustability, the drivers make it easy for luminaire manufacturers to design linear fixtures with desired lumen levels to suit the application.

Specifications

Input Volt. (Vac)	Output Power (W)	Output Voltage (V)	Output Current (A)	Efficiency@ Max Load and 75°C Case	Max Case Temp. (°C)	Input Current (A)	Max. Input Power (W)	THD @ Max Load (%)	Power Factor @ Max Load	Surge Protection (Ring Wave, KV)	Envir. Protection Rating	Dimming	Dimming Range (with specified dimmers)	Min. Output Current (A)	Other Comments
120	50	10 - 54	0.1 - 1.4	86	Life-75°C UL-85°C	0.49	58	<10%	>0.90	2.5	UL damp & dry	0-10V Analog Class 1 or Class 2 Wiring	1% ~ 100%	0.005	Dimming source current: 150 µA
277				88		0.21		<15%							

Enclosure

	In. (mm)
Case Length	14.17 (360)
Case Width	1.18 (30)
Case Height	1.00 (25.4)
Mounting Length	13.78 (350)

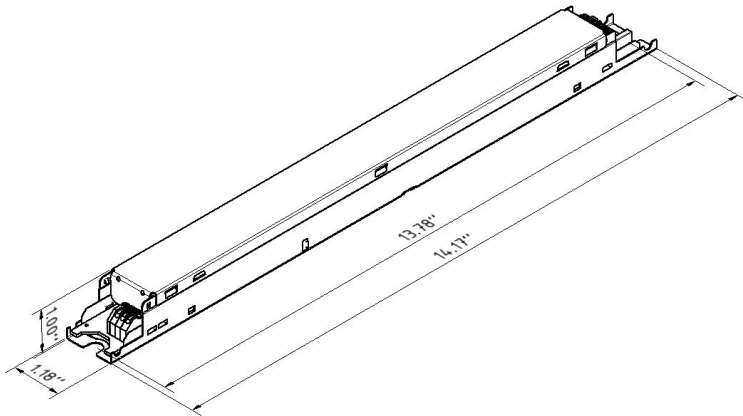

Wiring Diagram

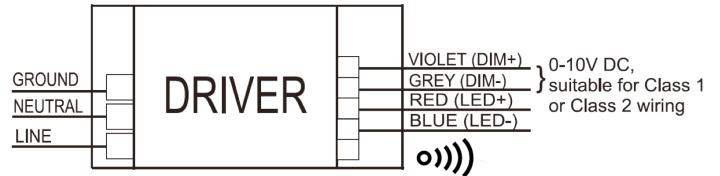

WARNING:
Install in accordance with National and Local Electrical Codes. Use 18 AWG Solid Copper Wire Strip Wire 3/8".

GROUNDING:
Driver case must be grounded.



Class P
LED class 2 output
For Dry and Damp Location
Use only within an enclosure



Intertek
Class P
Conforms to UL STD 8750
Certified to CAN/CSA STD
C22.2 No. 250.13



Xitanium XI050C140V054BST1

50W 0.1-1.4A 54V 0-10V INT (1% dim) with SimpleSet

Features

- 50,000+ hour lifetime¹
- SimpleSet programmable
- Large operating window
- 1% minimum dim level

Benefits

- Slim profile housing enables easy design-in with excellent thermal performance
- Enables simple, fast, flexible application-specific configurations
- Enables fixture designs with comprehensive application coverage for various loads and lumen levels

Application

- Indoor linear applications such as troffers and pendants
- Office
- Education
- Healthcare
- Retail
- Big box stores

Electrical Specifications

All the specifications are typical and at 25°C Tcase unless specified otherwise.

Product Data

Order Information	
Full Product Code	XI050C140V054BST1 (Mid-Pack, 18pcs/Box)
Line Frequency	50/60Hz
Min. Mains Voltage Operational	108 Vac
Max. Mains Voltage Operational	305 Vac
Output Information	
Maximum Open Circuit Voltage	< 60Vdc
Output Current Ripple (ripple = peak to average / average)	15% max @ max Iout 4% max @ Visible for stroboscopic frequency range 60Hz-3KHz
Output Current Tolerance (in the performance window)	<5%
Protections	Short Circuit, Open Circuit Protection for LED + and LED -, mis-wiring protection
Features	
0-10V Dimming	150µA source current from driver. See dim curve for detail.
AOC (Adjustable Output Current)	0.1A-1.4A via external resistor or SimpleSet programming (refer to graph and notes below)
Additional SimpleSet Configurable Features	Adjustable minimum dimming level, Dimming curve selection (linear or logarithmic), Adjustable output level, Adjustable output min, OEM write protection,
Environment & Approbation	
Operating Ambient Temp. Range	-20°C to +50°C
Max Case Temperature (Tcase)	85°C
Agency Approbations	UL8750, UL1310, CSA-C22.2 No. 250.13-17, CSA Class P, ETL Class P, UL Class P, NOM
Electromagnetic Compliance	FCC Title 47 Part 15 Class A
Audible Noise	<24dB Class A
Weight	0.58 Lbs / 0.265 kgs

1. Advance Xitanium LED drivers are manufactured to engineering standards correlating to a designed and average life expectancy of 50,000 hours of operation at maximum rated case temperature. Minimum 90% survivals based on MTBF modeling.

Xitanium XI050C140V054BST1

50W 0.1-1.4A 54V 0-10V INT (1% dim) with SimpleSet

Electrical Specifications

All the specifications are typical and at 25°C Tcase unless specified otherwise.

0-10V Dimming Curve

Dimming source current from the driver: 150µA (@ 0<Vdim<8V)

Minimum dim level: 1% of Iout (minimum 5mA)

Maximum output voltage on the dimming wires: 12V

Approved Dimmer List

Manufacturer	Manufacturer Part Number
Lutron	Visit www.lutron.com/advance for a list of dimmers (Mark VII) that will work with this driver
Leviton	IlumaTech IP7 series
Advance	Sunrise - SR1200ZTUNV

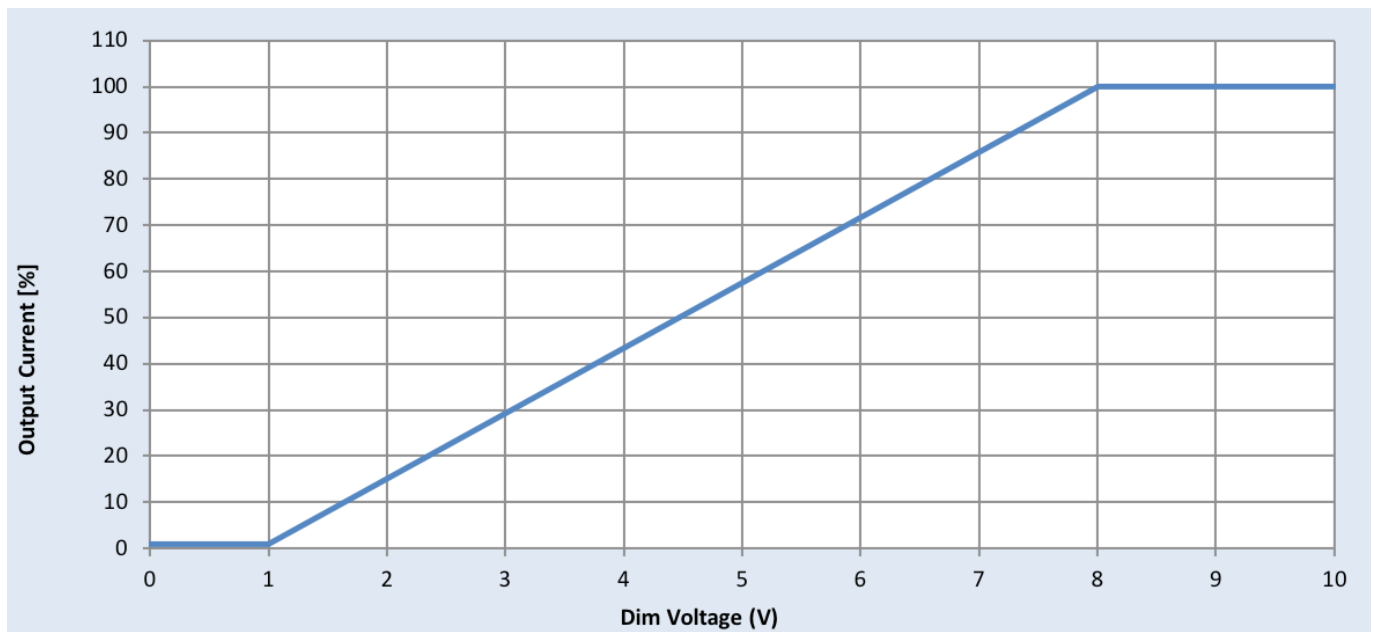

Xitanium XI050C140V054BST1

50W 0.1-1.4A 54V 0-10V INT (1% dim) with SimpleSet

Electrical Specifications

All the specifications are typical and at 25°C Tcase unless specified otherwise.

Driver Output Window

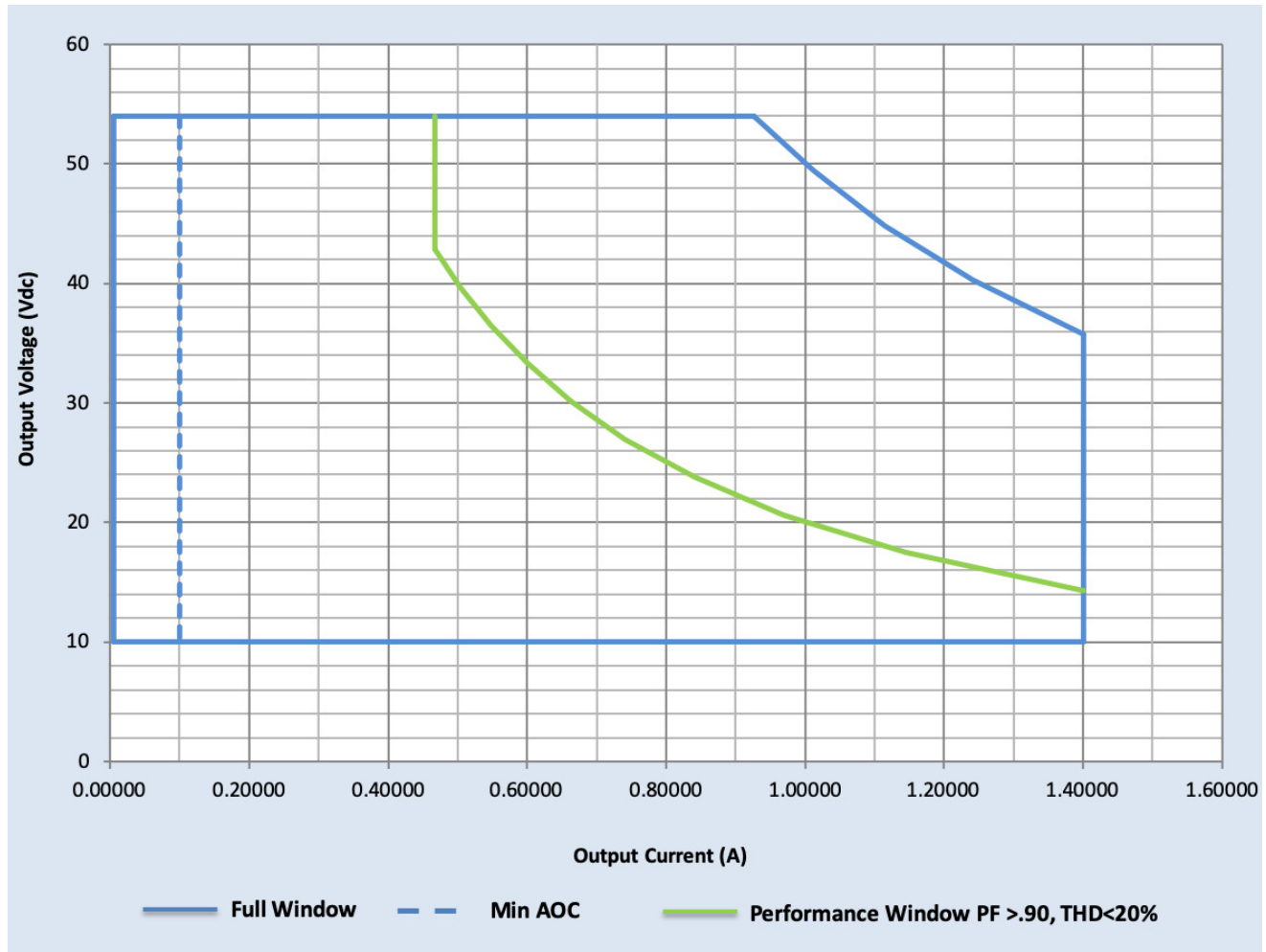

Notes

1. Factory default output current is 1.4A.
2. For dimming to a minimum level of 1% the output current setting through AOC should be $\geq 0.47A$.

Xitanium XI050C140V054BST1

50W 0.1-1.4A 54V 0-10V INT (1% dim) with SimpleSet

Electrical Specifications

All the specifications are typical and at 25°C Tcase unless specified otherwise.

Output Current Vs. Driver Case Temperature

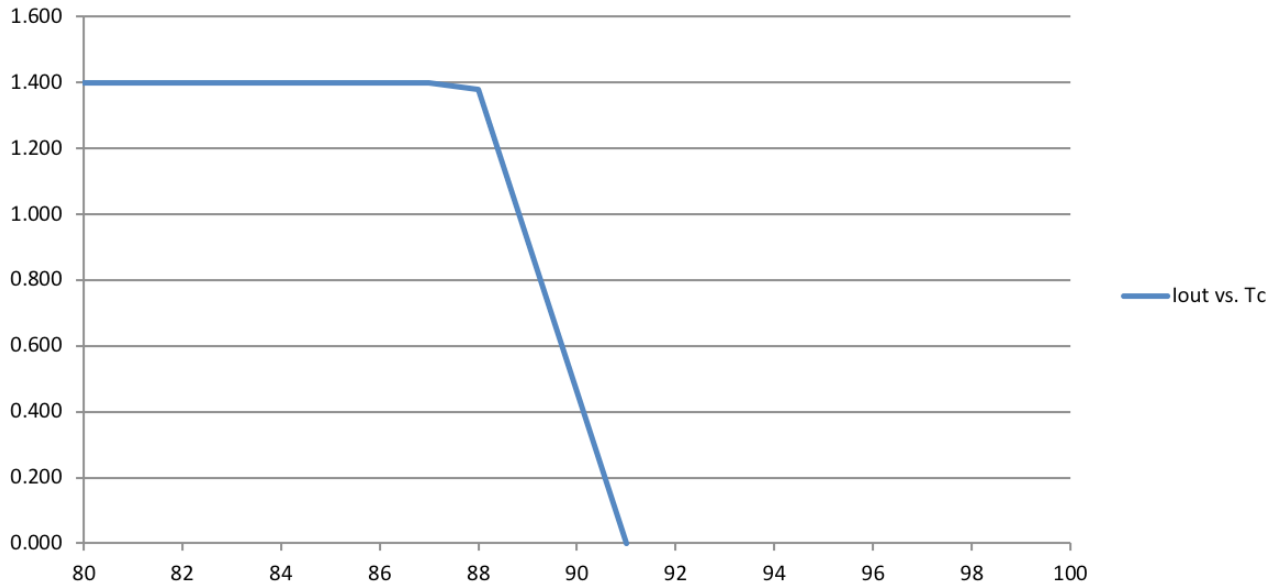

Note: There is ±5°C tolerance on the driver case temperature.

Driver Lifetime vs. Driver Case Temperature

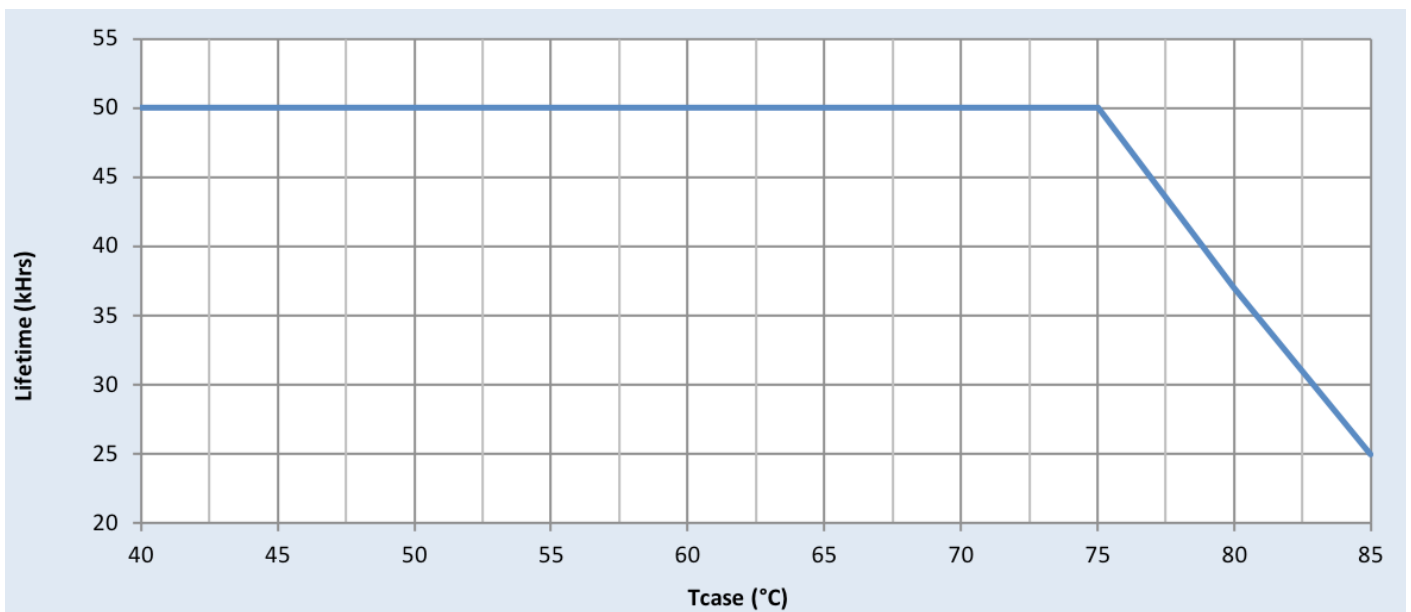

Xitanium XI050C140V054BST1

50W 0.1-1.4A 54V 0-10V INT (1% dim) with SimpleSet

Performance Characteristics

Based on measurements on a typical sample at 75°C case. The accuracy of the measurements is within the tolerance of the measurement instruments.

Efficiency Vs. Output Voltage at 120Vac

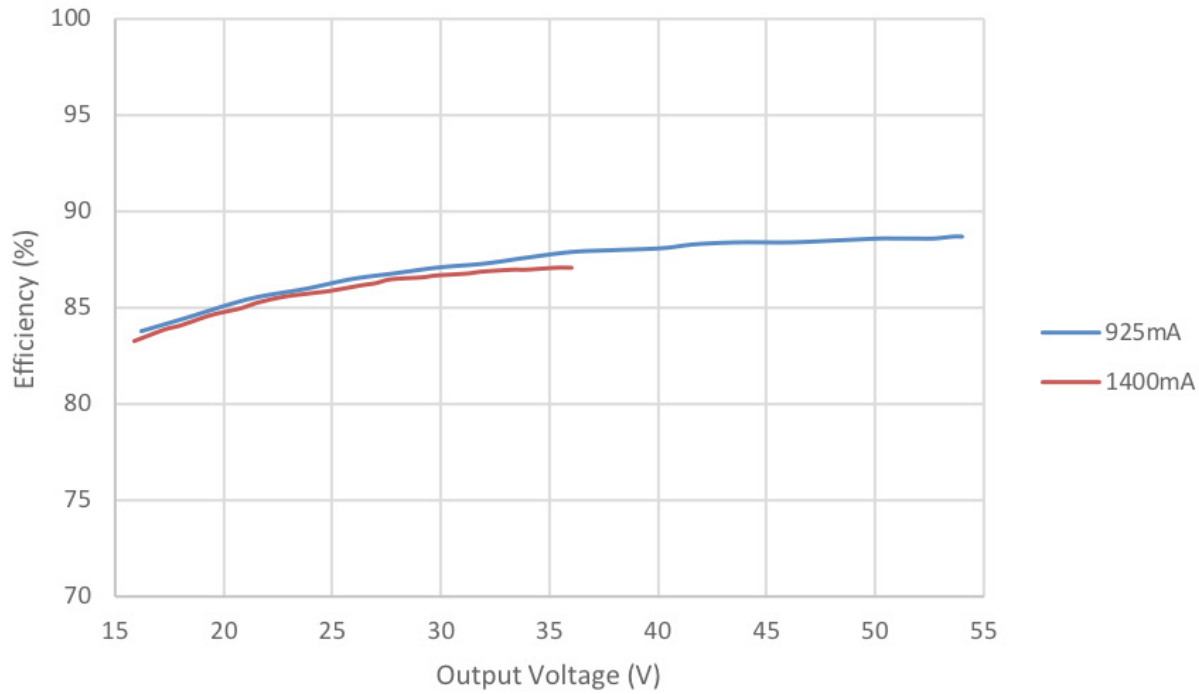

Efficiency Vs. Output Voltage at 277Vac

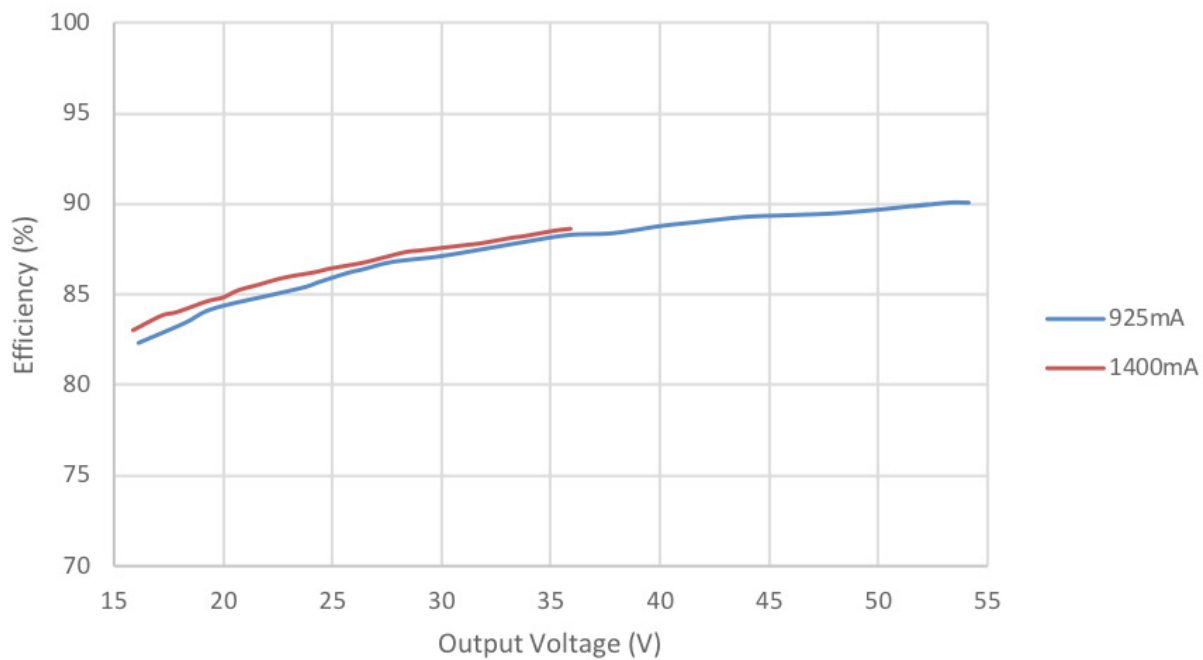

Xitanium XI050C140V054BST1

50W 0.1-1.4A 54V 0-10V INT (1% dim) with SimpleSet

Performance Characteristics

Based on measurements on a typical sample at 70°C case. The accuracy of the measurements is within the tolerance of the measurement instruments.

Power Factor Vs. Output Power

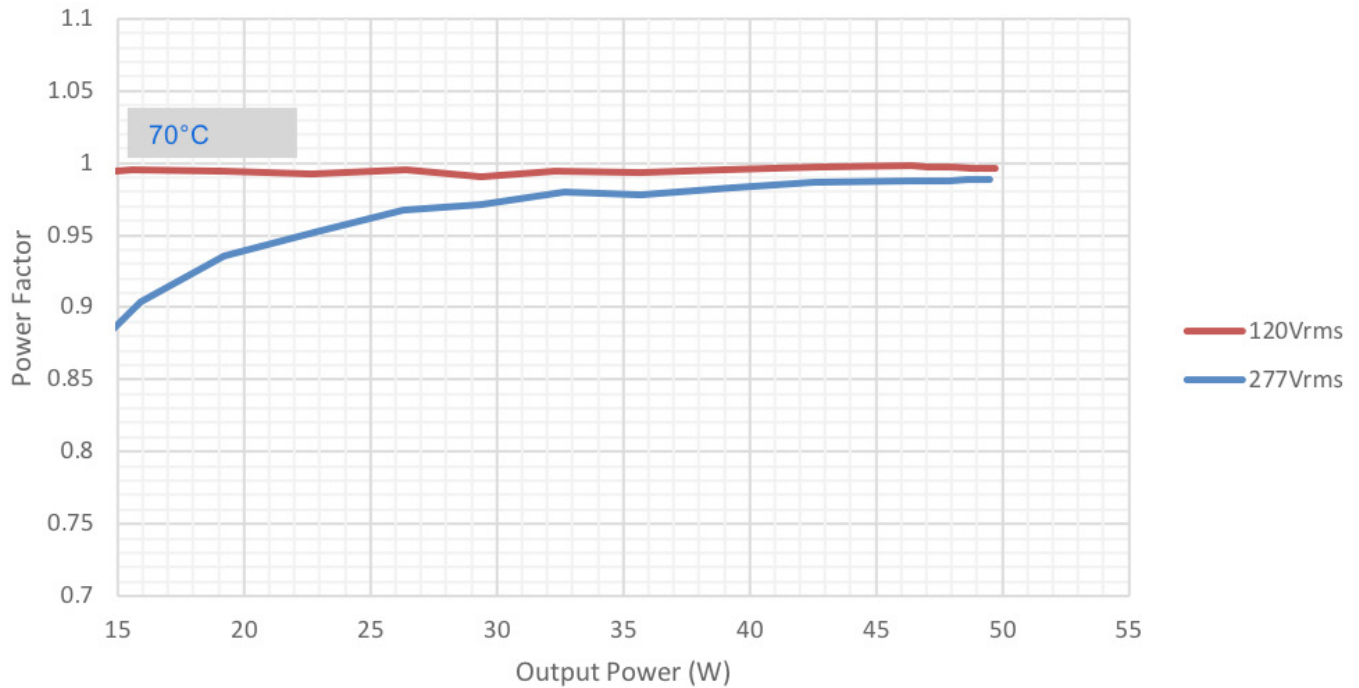

Total Harmonic Distortion (THD) Vs. Output Power

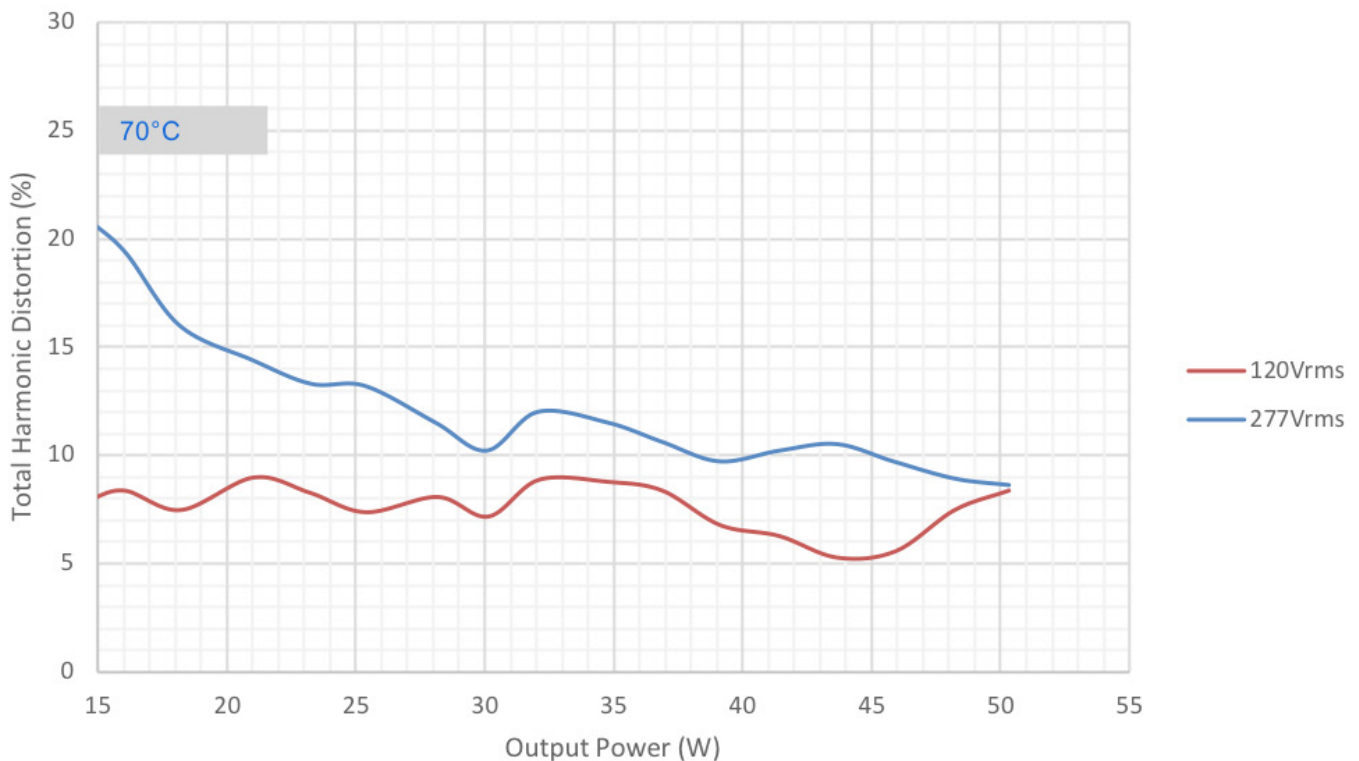

Xitanium XI050C140V054BST1

50W 0.1-1.4A 54V 0-10V INT (1% dim) with SimpleSet

Inrush Current Info

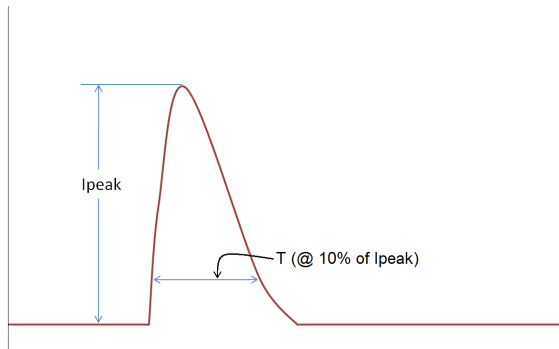

V_{in}	I_{peak}	$T (@ 10\% \text{ of } I_{peak})$
120 Vrms	16.6A	180 μ S
277 Vrms	55.7A	185 μ S

Inrush current is measured at peak of the corresponding line voltage. Source impedance per NEMA 410.

Lightning Surge Info

ANSI Surge Type	Differential Mode (L-N)	Common Mode (L-G, N-G, L&N-G)
100kHz Ring Wave (w/t 30 Ω)	>2.5KV	>2.5KV

Isolation

Isolation	Input	Output	0-10V	Enclosure
Input	–	2xU+1kV	2xU+1kV	2xU+1kV
Output	2xU+1kV	–	2xU+1kV	2xU+1kV
0-10V	2xU+1kV	2xU+1kV	–	2xU+1kV
Enclosure	2xU+1kV	2xU+1kV	2xU+1kV	–

U = Max input voltage

The information presented in this document is not intended as any commercial offer and does not form part of any quotation or contract.

